

CHAMBERLAIN™

LiftMaster™

PROFESSIONAL

Tubular Motors Product Catalog



Overview – Tubular Motors

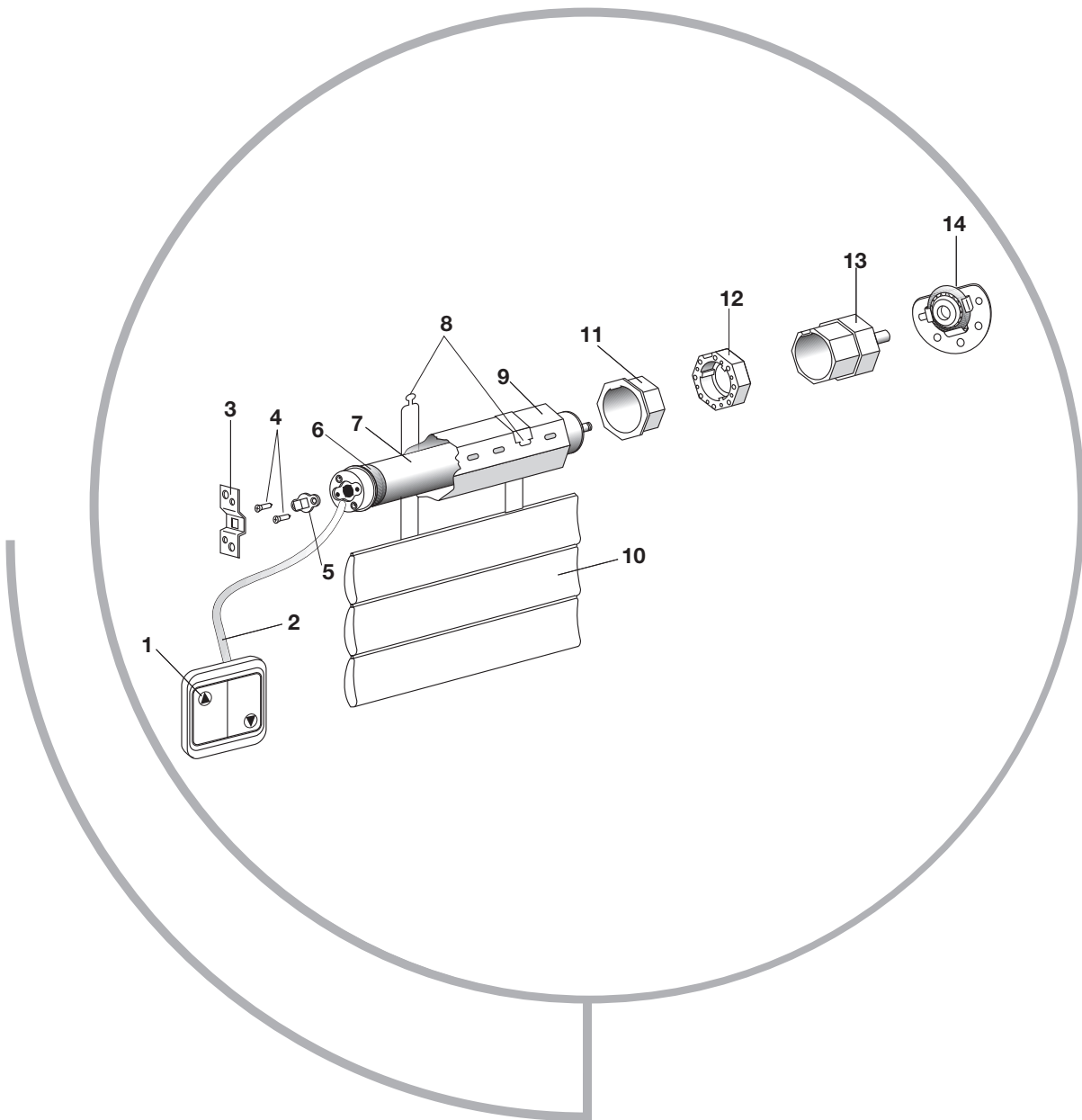

- (1)Wall control
- (2)Power cord
- (3)Wall bracket
- (4)Mounting screws
- (5)Wall bearing
- (6)Limit ring
- (7)Motor
- (8)Shutter connecting spring
- (9)Shutter tube
- (10)Shutter slat
- (11)Limit adapter
- (12)Drive adapter
- (13)End cap
- (14)Tube bracket

Tubular Motors with mechanical limit switches

CRX series

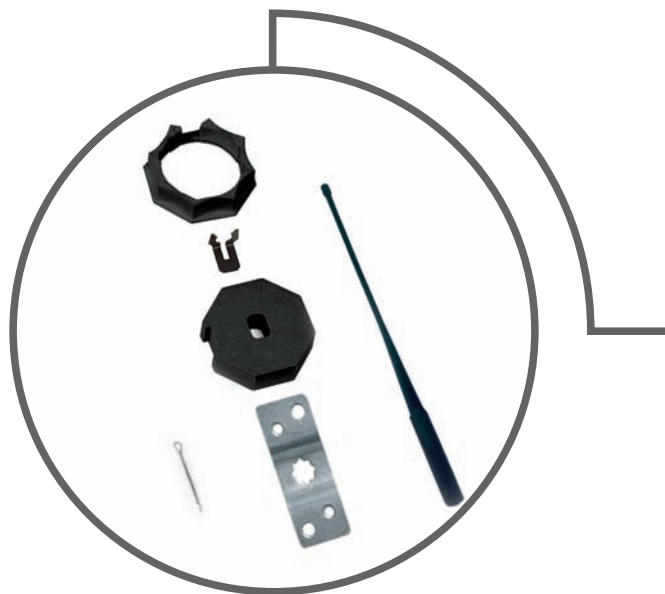
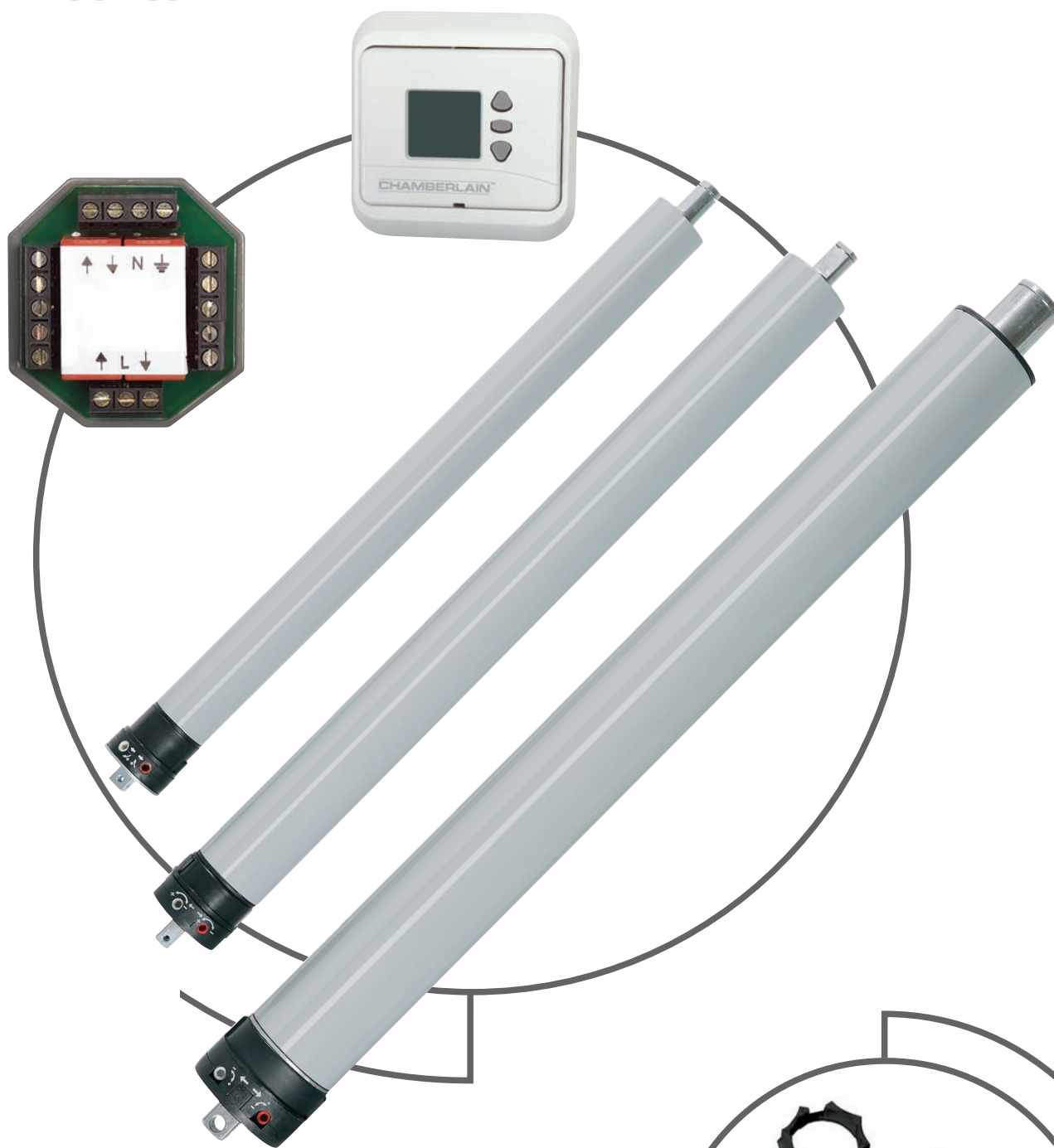

Technology and efficiency

Tubular motors of the CRX series are the right choice. For almost all applications at an excellent price-performance ratio LiftMaster has determined the course with this product program.

Quality and performance

Each motor is tested to DIN ISO 9000 standards and designed to operate smoothly over many years.

Professional standards

Reduced installation needs and lower costs

Pre-assembled adapters and wall bearings - this saves time and money.

Mechanical limit switches

Desired limits can be adjusted easily and at any time with the included adjustment tool.

Economical and practical

The packs of 6, 4 or 2 are practical and space-saving.

Product range & technical data

	Dia- meter	Torque	Speed	Voltage	Frequency	Power con- sumption	Motor- output	Duty cycle	Limit Switch Range	Number per Pack	incl. octagonal adapters
	mm	Nm	rpm	V	Hz	A	W	min.	R	Piece	mm
CRX101	35	10	17	230	50	0.53	121	4	39	6	40
CRX151	45	15	15	230	50	0.60	133	4	25	6	60
CRX251	45	25	15	230	50	0.89	191	4	25	6	60
CRX401	45	40	15	230	50	0.77	170	4	25	4	60
CRX501	45	50	12	230	50	0.86	191	4	25	4	60
CRX800	59	80	15	230	50	2.00	430	4	21	2	-
CRX1000	59	100	12	230	50	2.32	491	4	21	2	-
"Sprinter" tubular motors for sun protection											
CRX0628	35	6	28	230	50	0.53	121	4	39	6	40
CRX1026	45	10	26	230	50	0.64	145	4	25	6	60



Pack content

- Tubular motors with pre-assembled adapters and wall bearings
- Adapters for octagonal tubes (35mm and 45mm motors)
- Wall brackets
- Drive adapter safety catches
- Split pins
- Adjuster pins
- Manuals

2-year warranty

Install all equipment in compliance
with EN60335-2-103



Radio Tubular Motors with mechanical limit switches

CRX radio series

Maximum comfort

The CRX radio series from LiftMaster™ offers maximum comfort. Operate your shutters and sunblinds with ease thanks to the remote control feature available as standard.

Savings in time and money

Wireless technology dispenses with complicated cable installation. This enables you to save both time and money.



Product range & technical data

	Dia- meter	Torque	Speed	Voltage	Frequency	Power con- sumption	Motor- output	Duty cycle	Limit Switch Range	Number per Pack	incl. octagonal adapters
	mm	Nm	rpm	V	Hz	A	W	min.	R	Piece	mm
CRX101F	35	10	17	230	50	0.53	121	4	39	1	40
CRX151F	45	15	15	230	50	0.60	133	4	25	1	60
CRX251F	45	25	15	230	50	0.89	191	4	25	1	60
CRX401F	45	40	15	230	50	0.77	170	4	25	1	60
"Sprinter" tubular motors for sun protection											
CRX0628F	35	6	28	230	50	0.53	121	4	39	1	40
CRX1026F	45	10	26	230	50	0.64	145	4	25	1	60



Pack content

- Tubular motor with pre-assembled adapter and wall bearing
- 1-channel remote control with wall mount clip
- Adapter for octagonal tube
- Wall bracket
- Drive adapter safety catch
- Split pin
- Adjuster pin
- Manual

2-year warranty

Install all equipment in compliance with EN60335-2-103



Tubular Motors with mechanical limit switches and hand crank function

CRXN series

Product range & technical data

	Dia- meter	Torque	Speed	Voltage	Frequency	Power con- sumption	Motor- output	Duty cycle	Limit Switch Range	Number per Pack	incl. octagonal adapters
	mm	Nm	rpm	V	Hz	A	W	min.	R	Piece	mm
CRXN500	45	50	12	230	50	1.41	308	4	25	2	60
CRXN800	59	80	15	230	50	2.00	430	4	21	2	-
CRXN1000	59	100	12	230	50	2.32	491	4	21	2	-

All tubular motors with hand crank function have a transmission ratio of 30:1. This means, that 30 revolutions of the hand crank are necessary to rotate the tube once.

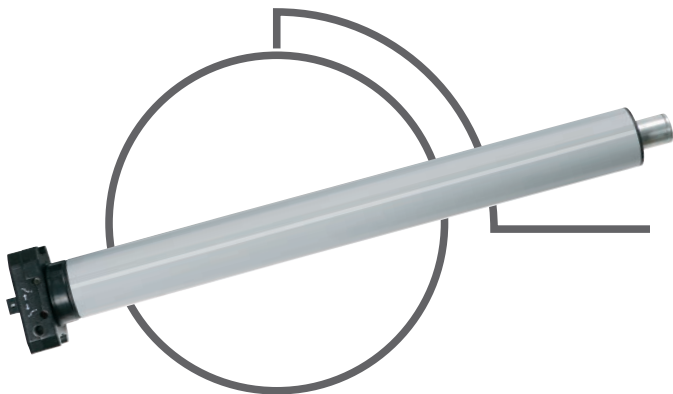

Pack content

- Tubular motors with hand crank function and pre-assembled wall bearings
- Adapters for octagonal tubes 60mm (CRXN500)
- Wall brackets
- Drive adapter safety catches
- Split pins
- Adjuster pins
- Manuals

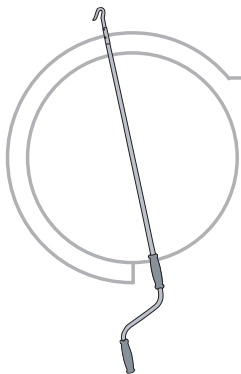

Hand cranks

- TOCE length: 140cm, with joint arm, material: steel
- TOCE2 length: 130cm, material: steel

Hand crank loops

- NHKZB5 length: 15cm, material: steel
- NHKZB3 length: 51cm, material: steel

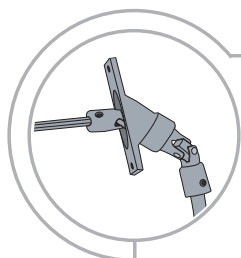
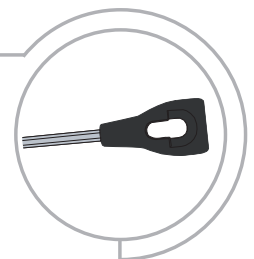

Hand crank loop for shutter box

- NHKZB6 length: 65cm, material: steel

2-year warranty

Install all equipment in compliance with EN60335-2-103

CE



Adapters

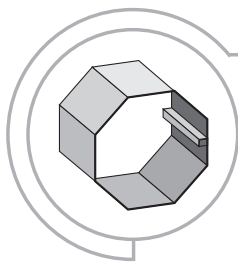

Octagonal tube

- 041ADA840 tube diameter 40mm, suitable for 35mm motors
- TAO50E tube diameter 50mm, suitable for 35mm motors
- TAO5045E tube diameter 50mm, suitable for 45mm motors
- 041ADA860 tube diameter 60mm, suitable for 45mm motors
- TAO70E tube diameter 70mm, suitable for 45mm motors
- TAO7059E tube diameter 70mm, suitable for 59mm motors
- TAO12559E tube diameter 125mm, suitable for 59mm motors, adapter re-enforced with steel

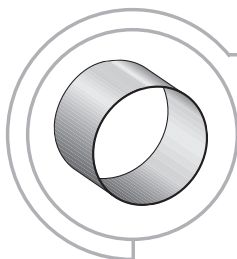

Round tube

- TAR40E tube diameter 40mm, suitable for 35mm motors
- TAR50E tube diameter 50mm, suitable for 35mm motors
- TAR85E tube diameter 85mm, suitable for 45mm motors
- TAR102R tube diameter 102mm, suitable for 59mm motors

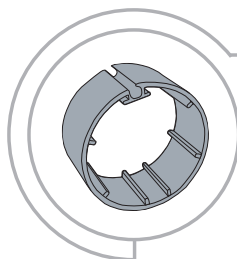

Round tube Acmeda

- TARAC44E tube diameter 44mm, suitable for 35mm motors

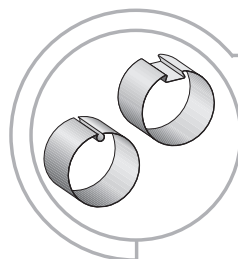

Awning tube (round groove, flat groove)

- TAA62E tube diameter 62mm, suitable for 45mm motors (flat groove only)
- TAA63E tube diameter 63mm, suitable for 45mm motors
- TAA70E tube diameter 70mm, suitable for 45mm motors
- TAA78E tube diameter 78mm, suitable for 45mm motors
- TAA7859E tube diameter 78mm, suitable for 59mm motors (round groove only)

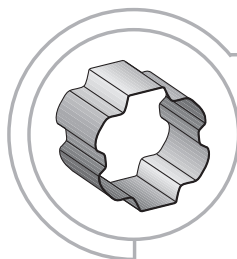

ZF tube

- TAZ54E tube diameter 54mm, suitable for 45mm motors
- TAZ64E tube diameter 64mm, suitable for 45mm motors

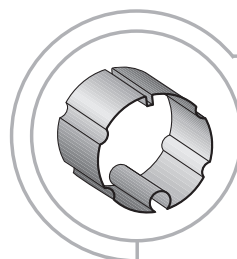

Forjas tube

- TAF70E tube diameter 70mm, suitable for 45mm motors

Adapters

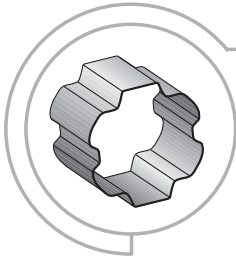

Profile tube

- TAP65E tube diameter 65mm, suitable for 45mm motors



Step-up adapter

- TAZW35E The step-up adapter is suitable for 35mm motors and permits the use of adapters with an interior diameter of 45mm

Wall brackets

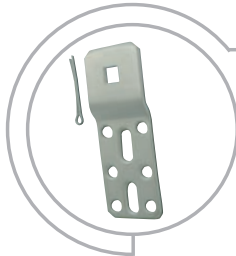

Universal bracket for prefabricated shutter box

- BMB2 suitable for 35mm and 45mm motors



Universal bracket (unroll-feature)

- BMBU-D suitable for 35mm and 45mm motors

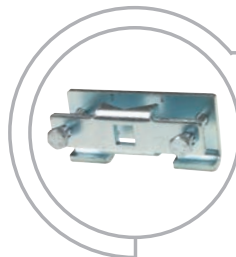

Bracket for retrofitting

- BMBNL-D suitable for 35mm and 45mm motors

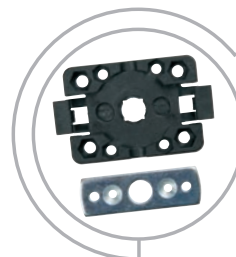

Clip bracket for front-mounted element

- BMBSL1-D suitable for 35mm motors



Bracket for sunblinds

- BMBSC-D suitable for 35mm and 45mm motors, max. 15Nm

Accessories



Programmable timer TCT3E

- Suitable for all tubular motors without radio
- Easily program or change timer programs with little instruction
- Control opening and closing times for each day or week and holidays
- Automatic or manual operation
- Compatible with LiftMaster™ light sensor TCLS4E



Light sensor TCLS4E

- Opens and closes your shutters depending on sunlight
- Is mounted directly on the window
- Compatible with LiftMaster™ programmable timer TCT3E



Wall switch CRS2

- Suitable for all tubular motors without radio
- This toggle switch for interior concealed installation is directly linked with the tubular motor



Wall switch CRS1

- Suitable for all tubular motors without radio
- This rotary switch for interior concealed installation is directly linked with the tubular motor

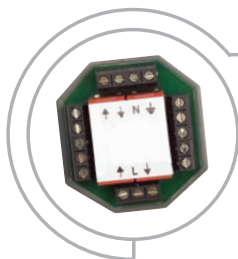

Central module CRC1

- Various motors can be connected in parallel to a programmable timer or a wall switch
- 1 relay per connected motor
- Operation of up to 6 motors via the central group switch
- Not necessary for radio tubular motors
- 230V/50Hz, max. 5A

Radio accessory program

The LiftMaster™ radio accessory program is not only designed for CRX radio tubular motors but can also be used for retrofitting all other LiftMaster tubular motors. This requires the external receiver CS8001.



1-channel remote control CS4330

- Remote control with wall mount clip
- Frequency 433MHz
- 3 buttons: UP, STOP, DOWN
- For CRX radio series
- Suitable for retrofitting (external receiver CS8001 necessary)



6-channel remote control CS4336

- Remote control with wall mount clip
- Frequency 433MHz
- Opens and closes up to 6 shutters – separately or simultaneously
- For CRX radio series
- Suitable for retrofitting (external receiver CS8001 necessary)

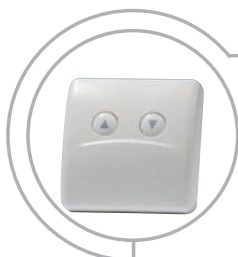

Radio wall switch CS7524

- Allows manual or automatic operation
- Two times of day programmable
- Switch for changing between summer and winter time
- Frequency 433MHz
- For CRX radio series
- Suitable for retrofitting (external receiver CS8001 necessary)



External receiver CS8001

- For almost all rolling shutter boxes
- Frequency 433MHz
- Suitable for CRX tubular motors (retrofitting)
- Compatible with all tubular motors

Wiring

Motor

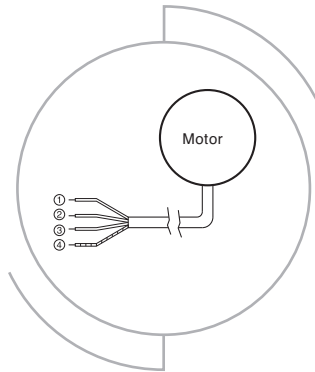

Color scale for motor wires

①	blue	Common conductor N
②	black	Phase direction of rotation 2
③	brown	Phase direction of rotation 1
④	yellow/green	Earth PE, \perp

Wall switch CRS1

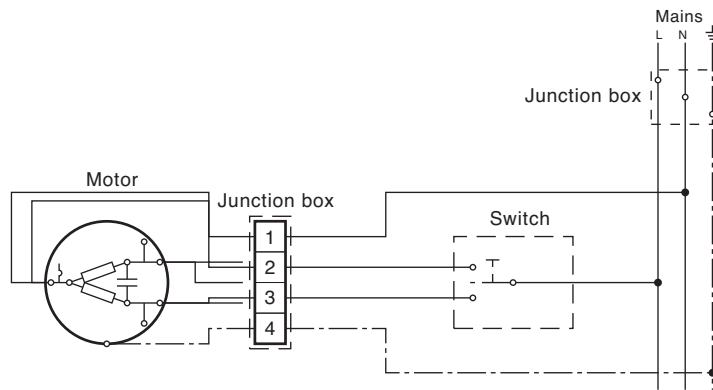

Programmable timer TCT3E

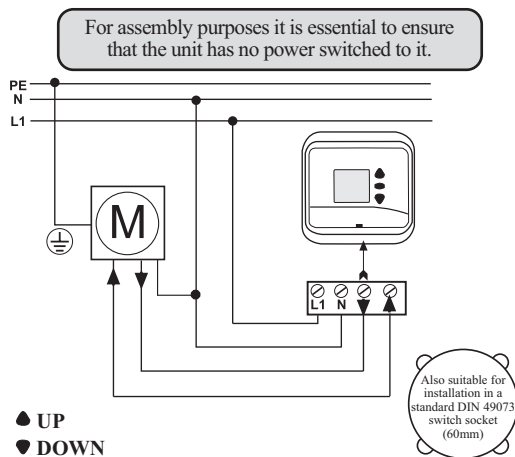
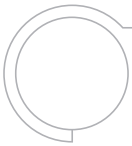

Application diagram

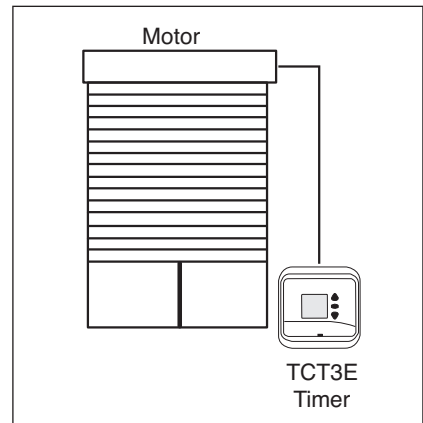

Application diagram central module CRC1

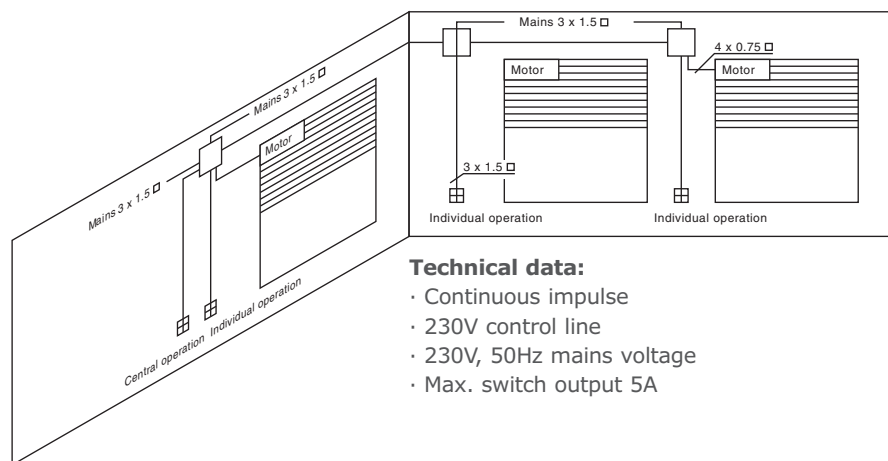
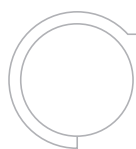

Technical data:

- Continuous impulse
- 230V control line
- 230V, 50Hz mains voltage
- Max. switch output 5A

Wiring central module CRC1

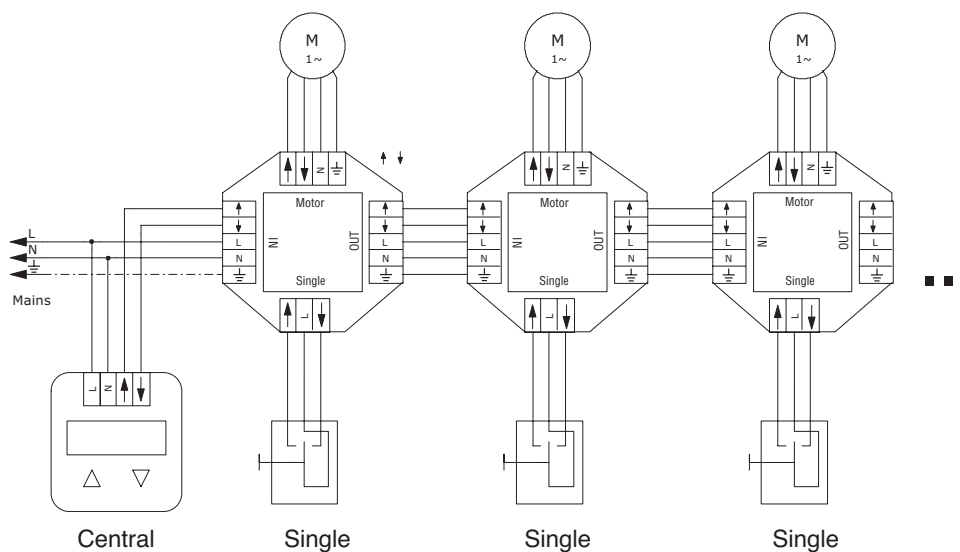

If all the drives are on the same current circuit, the control and connection lines can be laid together as a 5-cord wire. If more than 6 motors are connected to a line, a larger wire cross-section should be used.

de

Tel.: +49 (0) 68 38 90 72 50
Fax: +49 (0) 68 38 90 71 79

fr

Tel.: +33 (0) 03 87 98 62 84
Fax: +33 (0) 03 87 95 48 16

en

Tel.: +44 (0) 19 35 82 39 00
Fax: +44 (0) 19 35 82 38 99

it

Tel.: +39 03 63 38 21 00
Fax: +39 03 63 81 70 23

Chamberlain GmbH
Alfred-Nobel-Straße 4
66793 Saarwellingen
www.liftmaster.de

01.06.2008

9A7102E